

Ikegami

Unicam HD

Affordable 3-CMOS HDTV Camera System

HC-HD300



BROADCAST QUALITY

A new camera system,
which incorporates the quality of Ikegami.

In the world of broadcasting, the picture tells the story. That is why a camera for broadcast use must always provide superior performance. Only critical evaluation of the picture conveys the true value of the camera. Ikegami, a leading brand in the broadcasting industry, is introducing the HC-HD300, which like the models before it, will prove its true value over its lifetime.



Camera system - TV SKYLINE (HDK-970A/97A)



Camera system - PLASMA TV (HDK-95C)



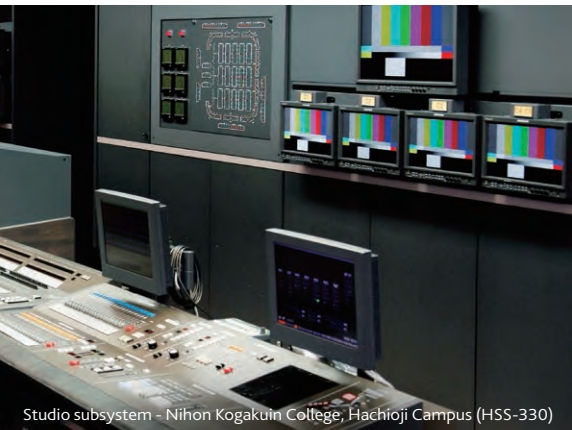

Studio subsystem - Nihon Kogakuin College, Hachioji Campus (HSS-330)



Camera system - QVC Japan (HDK-97A)

TRUST Confidence in "Ikegami"



Education, government, house of
worship and corporate video



Broadcasters



Studio-based production



COST EFFECTIVE

Maximum performance
for all members of your staff

A broadcast quality camera for users without a broadcast budget - this is the idea behind the creation of HC-HD300. It provides superior image performance which has been refined at major Japanese broadcasters, as well as, those in America, Europe and Asia, together with an affordable price. This camera provides the overall low cost of ownership you are looking for.



Live news,
sports and events

HIGH GRADE

High quality recognized around the world

It embodies the features which are valued in the broadcasting industry around the world. Even though the price is affordable, the care toward its performance, function, and construction is not lowered. That is the concept of HC-HD300. In addition to the advanced functionality of an Ikegami camera, newly developed 2.5 million pixel CMOS sensors realize 1000TVL resolution, 58dB signal-to-noise ratio, and F10(60Hz)/F11(50Hz) sensitivity.

High Performance Features

FUJINON High-Performance 17x Zoom Lens

The HC-HD300 is available with a newly developed Fujinon 1/3-inch 17x zoom lens. It offers an enhanced wide angle zoom range of 4.5-77mm, plus Quick Zoom and Cruise Zoom functions. Chromatic aberration correction data is built into this interchangeable 1/3-inch bayonet mount lens.



Newly developed High Performance Full HD 1/3-inch CMOS Sensors

The HC-HD300 utilize three 1/3-inch 2.5 megapixel CMOS sensors, each capable of capturing full HD 1920 x 1080 resolution images and a wide dynamic range of more than 600%, and giving you an excellent sensitivity of F10 (60Hz) / F11 (50Hz) and high signal-to-noise ratio.

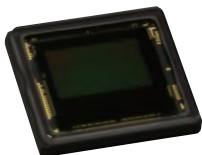

Advanced full digital 16-bit processing

This camera is designed from the start based on 16-bit DSP to maximize the benefits of high bit quantization. Especially for the dark areas of the picture, the higher gradation for gamma and other circuits improves the reproduction, providing for more natural color in the shadow areas of the picture. Up to 38-bits are used within the DSP.

Multi-Video Format

For High Definition, 1080/59.94i and 1080/50i as well as 720/59.94p and 720/50p are natively supported. In addition, Standard Definition, which is 480/59.94i(NTSC) and 576/50i (PAL), is also supported.

Dockable camera body

As a part of the UnicomHD product family, optional adaptors, such as FA (Fiber Adaptor), TA (Triax Adaptor) or CA (Camera Adaptor), can be mounted without any external cables depending on the application.



Lens Aberration Correction function

The Lens Aberration Correction function is newly incorporated for minimizing the blur and colored edges caused mainly by lens chromatic aberration.

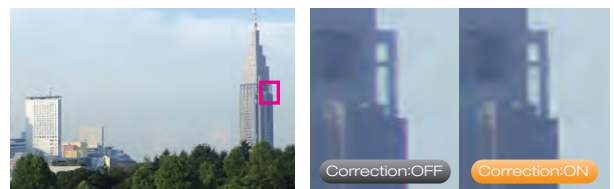

Quick EZ Focus Assist function

The Quick EZ Focus Assist function is a newly incorporated useful tool, providing very distinct enhancement to the viewfinder signal to enable the camera operator to make critical focus adjustment. The size of area, area color, edge color, and display time on the viewfinder are adjustable in the camera menu.

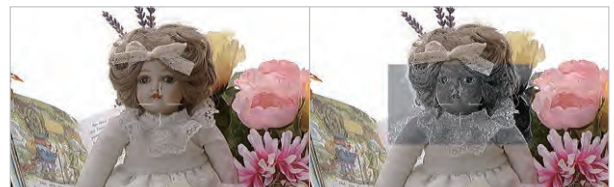

Advanced Digital Detail

Both horizontal and vertical Detail Correction circuits for red, green and blue signals are independently and digitally processed. You can obtain the full resolution of a high quality picture with extremely low noise, even under low-light shooting conditions.

Super Dynamic Compression (KNEE)

Built-in advanced digital KNEE function compresses high-light signals without changing the hue. It gives you more saturation and a naturally high-lighted picture rather than washing out the color.

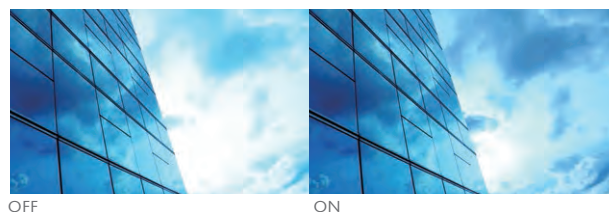

Ergonomic Design for easy operation

This camera has various unique features based upon ergonomic design, bearing in mind the needs of the customers Ikegami has cultivated in the broadcasting industry over many years. The HC-HD300 can be comfortably and easily used by anyone.



1 A 2" HD color viewfinder which is extremely clear and makes it easy to focus the lens. Includes a VF adaptor which enables front to back and side to side adjustment while carrying the camera on your shoulder.

2 Intercom, PGM volume, and intercom mic switch can be operated while carrying on your shoulder.



3 The control panel doesn't stick out and won't get in the way when you are carrying the camera. Close the cover over it to prevent accidental operation or getting caught on your clothes.



4-1 REAR TALLY can be turned ON/OFF.

4-2 Intercom control selection to switch between Rear control for when the camera is on the tripod, and Front control for when the camera is on the shoulder.

4-3 RET selection switch enables independent assignment to RET-1 and RET-2 with a maximum of 4 channels input to the BS.

4-4 Intercom and PGM1 and PGM2 volume enables independent adjustment at the 2 channels of intercom.

4-5 Mic selection switch allows selecting the channel to talk on

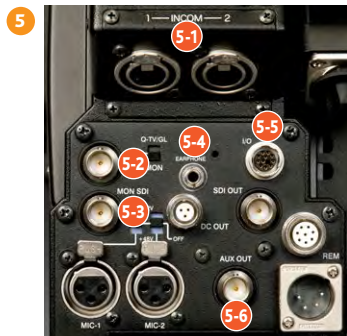

5-1 Two Intercom headset connectors for the camera operator.

5-2 Q-TV connection enables the output of an analog composite signal for a prompter.

5-3 MON OUT enables VF image output (mixing VF character and VF DTL edge).

5-4 Earphone can be used instead of an intercom headset.

5-5 I/O connector supports accessory interface.

5-6 AUX connector provides analog composite output.



6-1 RET switches enable RET selection when carrying the camera by the handle. RET-2 can be also set to an intercom MIC switch.

6-2 A thick handle grip doesn't slip easily and makes it easy to turn the camera left and right.

6-3 The Cooling FAN doesn't emit warm air on the cameraman side. It can be stopped for silent shooting when necessary.

7 V-wedge to which a studio VF can be attached with a single touch



8 Rotating camera connector doesn't put stress on the cable



9



9-1 Motor servo 4-position ND filter

9-2 PERSONAL FUNCTION switch which can be set to operate items according to the user's preference.

9-3 Intercom mic switch can be operated at the front of the camera.

9-4 Rotary encoder switch which makes menu navigation easy

10 Camera number plate holder for easy exchange of camera number indication.



11 Shoulder pad with good friction and doesn't put strain on the shoulder. Easy to grip the shoulder pad with your hand for low shots.



12 Additional RET switches available when carrying the camera off the shoulder.



FLEXIBLE

Emulates the flexible operation of UnicamHD

The HC-HD300 incorporates the operational flexibility of the UnicamHD series of dockable cameras for broadcast use. Depending on the application, it can be docked with a fiber adaptor, a triax adaptor, etc. It realizes the goal of flexible use and efficient operation.

New Fiber Based Remote System for affordable and flexible integration

These three new products, FA-300 Fiber Adaptor, BSF-300 Base Station and PSU-300 Power Supply Extension unit, have a OpticalCON DUO connectors for fiber cable connection. It can accept either a common optical LC-Duplex connector for single-mode fiber cables, or OpticalCON DUO connector for hybrid cables. This enables affordable and flexible integration for a variety of applications.

Cable connector

- Ruggedized and dirt-protected 2-channel fiber optic connection system
- Accommodates standard optical LC-Duplex connectors
- Excellent dust and dirt protection due to automatic sealing shutter with silicone gasket

Chassis Connector

- Accommodates standard LC connectors mounted from the rear for simple installation
- Shutter with silicone gasket protects optical connection from dust and dirt

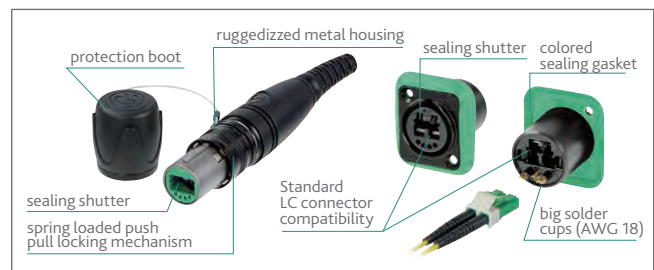

One small, lightweight fiber optics cable does it all for every application

Unlike bulky Multi-core cables, only a duplex lightweight single mode fiber or hybrid fiber cable is required between the camera adaptor and base station for robust two-way communications and to carry all of the required signals necessary for operation of the camera and associated production equipment.

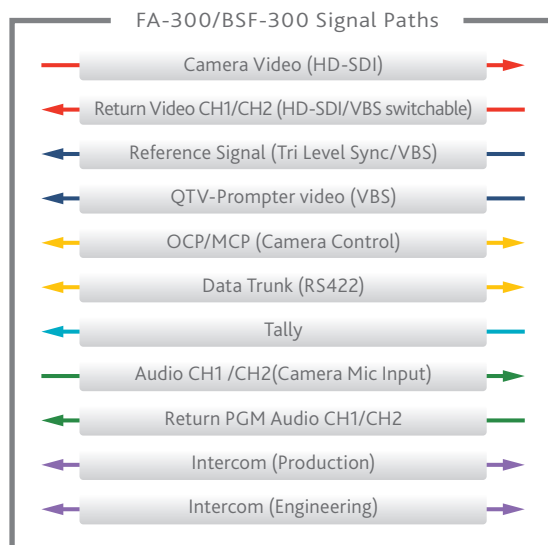

FA-300 Fiber Adaptor/ BSF-300 Base Station

The lightweight and compact size (1.5 RU) BSF-300 is easily integrated into any studio, mobile truck, or portable flypack. When you use a hybrid fiber cable, the base station provides power to the fiber adaptor and the camera itself.



Note: SE-H750 System Expander is NOT applicable to FA-300 due to power limitation.

PSU-300 Power Supply Extension Unit

It supplies power to the fiber adaptor and camera head via a hybrid cable, and extends the overall cable length to make the system flexible.

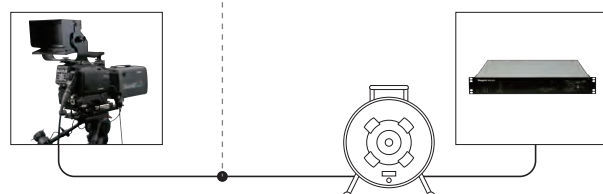

New Remote System – Cable Configurations

① Powered system using Hybrid fiber cable – Up to 350m(1148ft) with VFL-200HD/250m(820ft) with VFL-P700

The maximum cable length between the FA-300 Fiber Adaptor and the BSF-300 Base station is 250m (820ft) with power supplied from the base station.

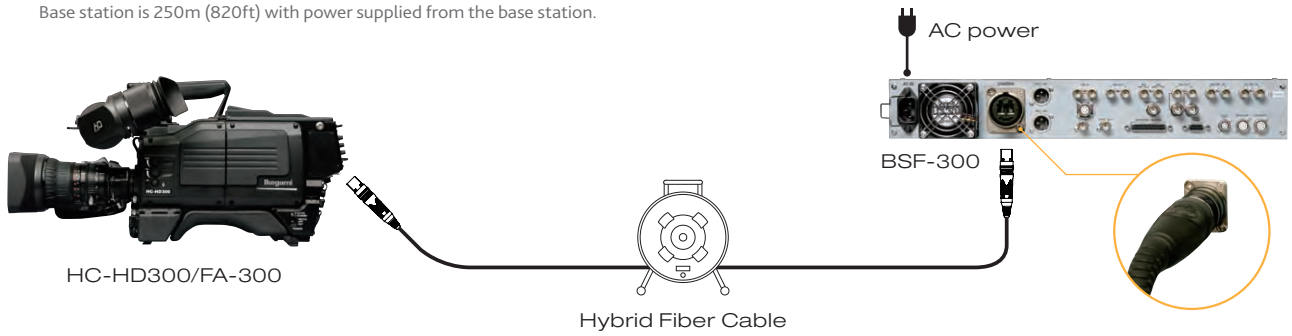

② Unpowered system using single mode fiber cable – Up to 10km (32,800ft)

The maximum cable length between the FA-300 Fiber adaptor and the BSF-300 Base station is 10km (32,800ft) using dual single mode fiber cable. A local power supply for the camera and fiber adaptor is required.

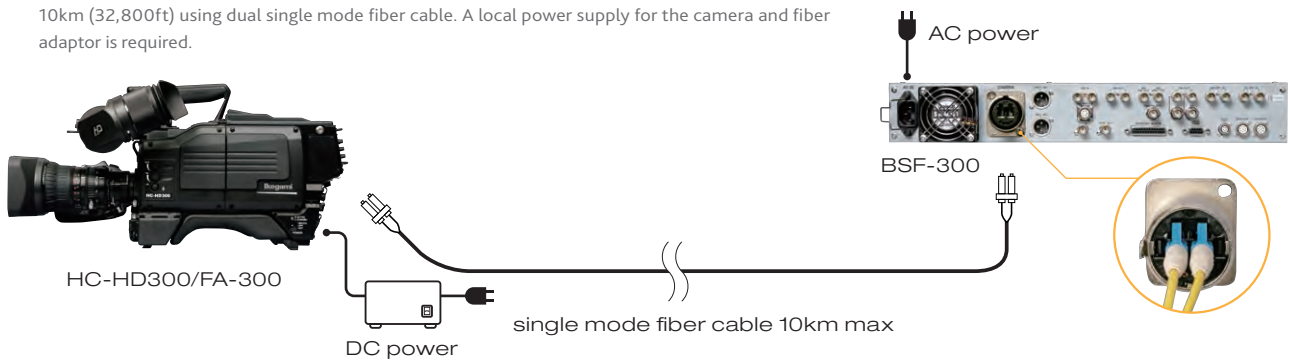

③ Combination of powered system with hybrid cable and unpowered system with single mode fiber cable, with PSU-300 power supply extension unit.

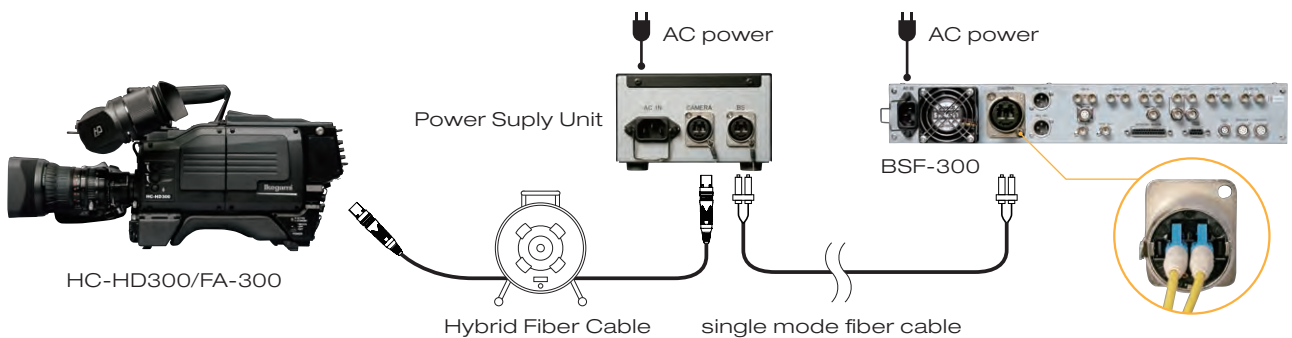

NOTE: The cable distances are subject to change depending on the power consumption of the camera and accessories, such as viewfinder and lens.

INTEGRATION

Wide range of accessories for system integration

We have prepared many accessories to allow our customers to optimize the integration of the camera. The HC-HD300 is first and foremost a studio camera system, but with the camera adaptor accessory, it is equally suited as a self-contained camera, a wireless camera, and a camera adaptor. It is possible to put together a system with consistent Ikegami quality from image acquisition to image display.

Docking with CA-75HD Camera Adaptor, makes stand-alone operation possible

In the stand-alone configuration you can attach with external devices, such as wireless transmission or solid state/HDD recorder, making the camera suitable for live sports, news gathering or field production.

The HC-HD300 can interface with portable recorders via SDI to control the REC trigger, display status such as REC tally and remaining recording time. Please visit the Ikegami web site (<http://www.ikegami.co.jp/global/index.html>) for the latest status information for each external device.



Configuration with HC-HD300, CA-75HD and Atomos Samurai Blade

OCP-10 Operation Panel

The OCP-10 is a newly designed small and compact operation panel to connect with a Base Station, such as the BSF-300, or Camera Adaptor, CA-75HD, for camera control. It can control basic functions of the camera, such as Iris, White Balance, Black Balance, Paint, Gamma and Master Black and it is ideal for field production or under limited space situations, such as small mobile trucks, or portable flypaks.



Standard System Configurations

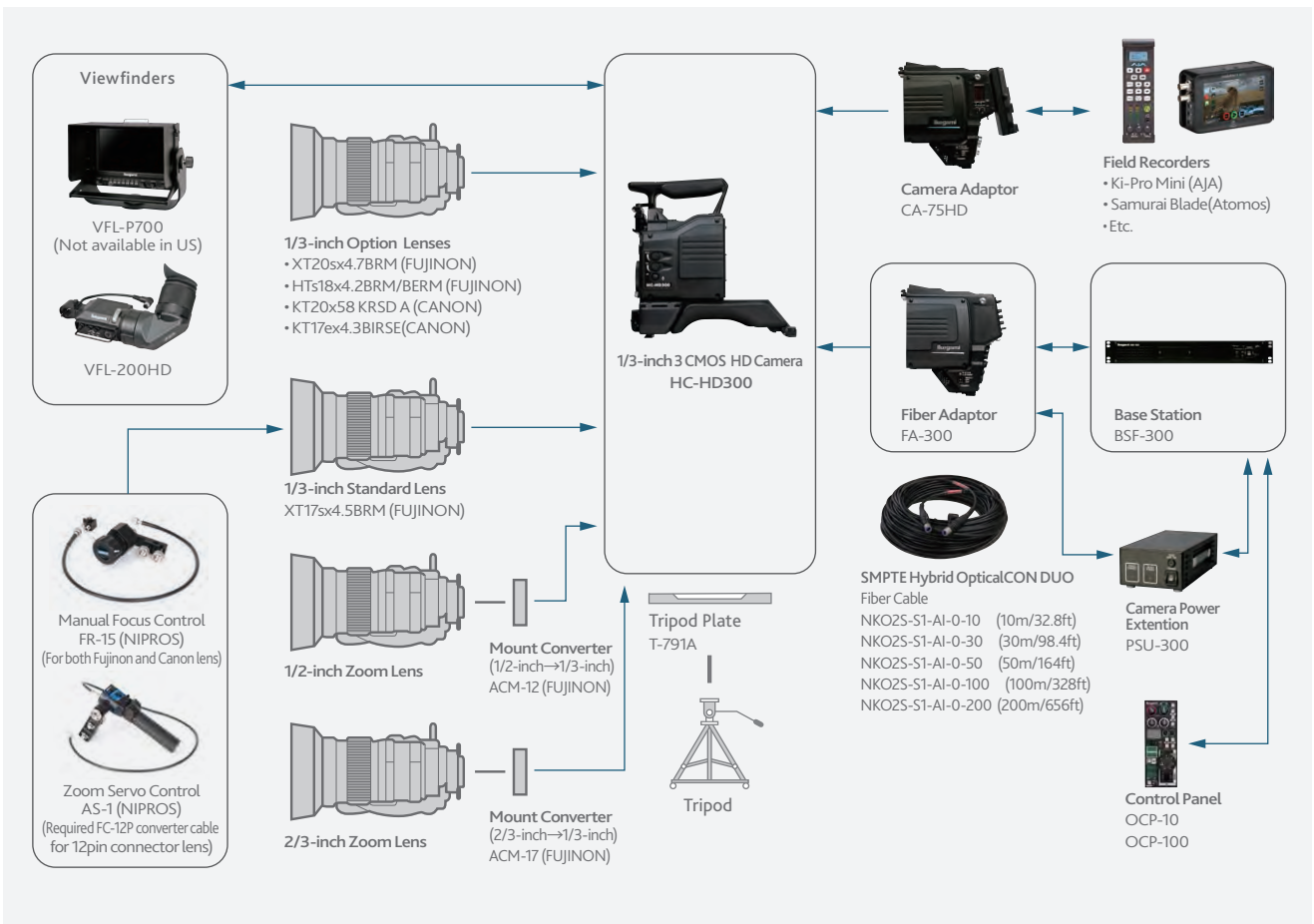

Optional Accessories



XT17sX4.5BRM(FUJINON)
XT20sX4.7BRM(FUJINON)
1/3-inch Zoom Lens



HTs18x4.2BERM(FUJINON)
HTs18x4.2BERM(FUJINON)
1/3-inch Zoom Lens



KT17eX4.3BIRSE(CANON)
1/3-inch Zoom Lens
with 2X extender



KT20X5B KRSD A(CANON)
1/3-inch Zoom Lens



ACM-17 (FUJINON)
2/3-inch Bayonet Mount Adaptor
ACM-12 (FUJINON)
1/2-inch Bayonet Mount Adaptor



AS-1 (NIPROS)
Zoom Servo Control
(Required FC-12P converter cable
for 12pin connector lens)



FR-15 (NIPROS)
Manual Focus Control
(For both Fujinon and Canon lens)



XA22x7BES (FUJINON)
2/3-inch 22x Box type Studio Lens



FA-55
Fiber Camera Adaptor



DTA-55
Digital Triax Camera Adaptor



VFL-200HD
2-inch LCD Viewfinder



VFL-P700
7-inch LCD Studio Viewfinder
(Not available in US)



BSF-55
Fiber Base Station



BST-55
Triax Base Station



CA-75HD
Camera Adaptor



OCP-100
Operation Control Panel



NKO2S-S1-AI-0-10 (10m/32.8ft)
NKO2S-S1-AI-0-30 (30m/98.4ft)
NKO2S-S1-AI-0-50 (50m/164ft)
NKO2S-S1-AI-0-100 (100m/328ft)
NKO2S-S1-AI-0-200 (200m/656ft)
SMPTE Hybrid OpticalCON
DUO Fiber cable



NAO2S-H1W-A (NEUTRIK)
OpticalCON
DUO Coupler Adaptor



T-791A
Tripod Mounting Plate



HLM-3250W
FHD 32-inch LCD Monitor



HLM-2450WB
WUXGA 24-inch LCD Monitor



HLM-1751WR
FHD 17-inch LCD Monitor



HLM-1705WR
FHD 17-inch LCD Monitor



HLM-905WR
WXGA 9-inch LCD Monitor



VF700W
7 inch Viewfinder/Field Monitor
(Available only in US)

Specifications

HC-HD300 Camera with FA-300

Output Video Formats	1920 x 1080/59.94i, 1920 x 1080/50i, 1280 x 720/59.94p, 1280 x 720/50p, 720 x 480/59.94i (NTSC), 720 x 576/50i (PAL)				
Image Sensor	1/3-inch 2.5 million pixel progressive scan 3 CMOS				
Optical System	1/3-inch RGB prism				
Lens Mount	1/3-inch bayonet mount				
Filter	Optical Filter (servo)	1	2	3	4
		ND	100%	25%	6.20%
Electronic Color Compensation		A	B	C	D
		ECC	3200K	4300K	6300K
Sensitivity	F10 (1080/59.94i) / F11 (1080/50i) typical at 2000 lx (White reflection 89.9%)				
S/N Ratio	58dB typical (1080/59.94i)				
Limiting Resolution	1000TV lines typical (1080/59.94i)				
Gain	-6, -3, 0, +3, +6, +9, +12, +18dB				
Electronic Shutter	1/100, 1/120, 1/250, 1/500, 1/1000, 1/2000				
Operating Temperature	-20°C to +45°C (-4°F to +113°F)				
Operating Humidity	30% to 90% (non-condensing)				
Operating Voltage	DC +11 to +16V				
Weight	4.5kg(9.92lbs) with FA-300				
Dimensions	W138.5 x H270 x D337 mm (W5.5 x H10.6 x D13.3 inches) (excluding protrusions) (with FA-300)				
Power Consumption	19W (without FA-300)				
Input signals					
External Sync Signal	SYNC 0.6Vp-p ±6dB 75ohm BNC type 1ch				
Audio Signal	-60 to +4dB (Variable) / -20dB (Fixed) XLR type 2ch (600ohm balanced)				
Intercom Signal	XLR type or 110 type 2ch				
Output signals					
Main Video Signal	Y,Pb,Pr 4:2:2 serial digital, Fiber optic connector 1ch				
SDI OUT	HD-SDI, BNC type 1ch				
MON SDI	HD-SDI, BNC type 1ch (VF, RET, or Main video selectable by menu)				
Q-TV	VBS signal, BNC type 1ch (QTV or Mon video (HD-Y signal) switch selectable)				
AUX OUT	VBS signal, BNC type 1ch (QTV-1 or Main video selectable by menu)				
DC OUT	+12VDC 500mA (max), 4-pin type 1ch				

BSF-300 Base Station

Operating Humidity	30% to 90% (non-condensing)
Operating Voltage	AC100V to 240V ±10%
Weight	Approx. 7kg (15.4lbs)
Dimensions	W483 x H66.4 x D405 mm (W19 x H2.6 x D15.9 inches) (excluding protrusions)
Power Consumption	Approx. 55VA (BSF-300 only)
Power supply to fiber adaptor	240W maximum (including cable loss)
Input signals	
External Genlock	BNC type, 1ch (HDTV/SDTV auto detect) HD: PS(1Vp-p) or Tri-Sync Signal(0.6Vp-p±6dB) 75ohm bridged SD: VBS(1Vp-p) or BBS 75ohm bridged
SDI Return Video Signal	75ohm Single End, BNC type 2ch (HD/SD SDI selectable)
VBS Return Video Signal	75ohm Single End, BNC type 2ch
Q-TV Signal	VBS 1Vp-p 75ohm Single End, BNC type 1ch
Intercom/Tally	
Intercom(ENG/PROD)	4-Wire, Clearcom or RTS selectable
4-Wire	0dBm 600 ohm 2ch
Clearcom	-15dBs 200 ohm 2ch
RTS	0dBs 200 ohm 2ch
PGM(Program Sound)	0dBs 600 ohm/10k ohm switchable 2ch
Tally	R/G 2ch
Output signals	
HD-SDI/SD-SDI Signal	HD-SDI(SMPTE292M) /SD-SDI(SMPTE259M), 75ohm BNC type 4ch(HD-SDI/SD-SDI selectable)
WFM Signal	Serial Digital 75ohm BNC type 1ch (HD-SDI/SD-SDI selectable)
PM Signal	Serial Digital or VBS 75ohm BNC type 1ch (HD-SDI/SD-SDI selectable)
VBS Signal	1.0Vp-p 75ohm BNC type 2ch
MIC	0dBs/+4dBs Low 2ch

OCP-10 Operation Panel

Functions	
GAIN	R Gain/B Gain
F.VR1/F.VR2	User Assignable
PEDESTAL	Master control
IRIS	Full open-close control
ON/OFF Control	ENABLE/AWB/ABB/AUTO IRIS/KNOB FREE/SCENE/FULL IRIS/CALL/F.SW1/ F.SW2
General	
Power requirements	DC +12V (+9 to +18V)
Power consumption:	Approx. 3W
Operating temperature:	0 to +45°C(+32 to +113°F)
Operating humidity:	30% to 90%
Dimensions	W60 x H94 x D160 mm (W2.3 x H3.7 x D6.3 inches)
Maximum cable distance	100m (328ft)

Product names and company names mentioned in this catalogue are trademarks and/or registered trademarks of their respective companies. Design and specifications are subject to change without notice.

Ikegami Tsushinki Co.,Ltd.

■ URL : <http://www.ikegami.co.jp/en/>

■ Head Office : 5-6-16 Ikegami, Ohta-ku, Tokyo 146-8567, Japan TEL.03-5700-1111 / FAX.03-5700-1137
 ■ Overseas Sales Division : 5-6-16 Ikegami, Ohta-ku, Tokyo 146-8567, Japan TEL.03-5700-4117 / FAX.03-5748-2200
 ■ Beijing Office : Room No.307 Tower B, Jia Tai International Mansion No.41East Fourth Ring Road, Chaoyang District, Beijing China ... TEL.010-85710350 / FAX.010-85711804

Ikegami Electronics (U.S.A.), INC.

■ URL : <http://www.ikegami.com>

■ Headquarters : 37 BROOK AVENUE, MAYWOOD, NJ 07607 TEL.(201) 368-9171 / FAX.(201) 569-1626

Ikegami Electronics (Europe) GmbH

■ URL : <http://de.ikegami.co.jp>

■ Headquarters : Ikegami Strasse 1, D-41460 Neuss, Germany TEL.02131-1230/FAX.02131-102820
 ■ U.K. Branch : 1 Windmill Business Village, Brooklands Close, Sunbury on Thames, TW16 7DY, England TEL.01932-769700 / FAX.01932-769710

Ikegami Electronics Asia Pacific Pte.Ltd.

■ URL : <http://sg.ikegami.co.jp>

■ Headquarters : 1 Tampines Central 5, #3-3 CPF Tampines Building, Singapore 529508 TEL.6260-8820 / FAX.6260-8896

U302A149-IB2

